

Vite specifica per fissaggi di lamiera di copertura e facciate metalliche prefabbricate su profilati leggeri e pesanti da 1,5 a 8 mm di spessore senza maschiatura preventiva.

- **Testa con chiave esagonale K10** a spigoli vivi dotata di collare cavo, studiata per l'alloggiamento ottimale della rondella elastica di tenuta contro le infiltrazioni d'acqua.

- **Filettatura BS autofilettante** e con scanalature automaschianti, che rende possibile il suo impiego in spessori elevati, senza maschiatura preventiva.

- **Nuovo trattamento galvanico CHROMITING®** di colore iridescente (di minore impatto visivo sul pannello) con resistenza alla corrosione degli agenti atmosferici ed all'inquinamento di molto superiore a tutte le normali zincature o rivestimenti metallici

Resistenza alla corrosione in Nebbia Salma >800h.

**Autofilettante
ed automaschiante**

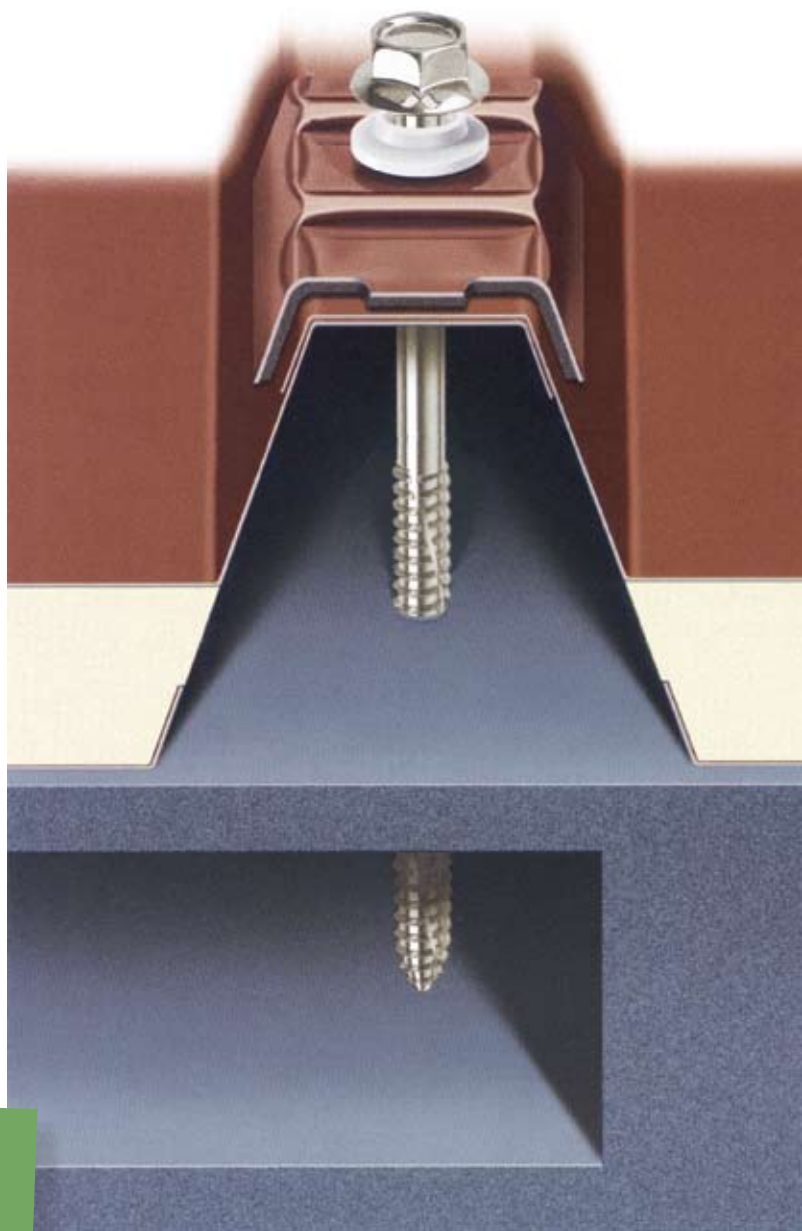

Rondella Elastica



Autofilettante ed automaschiante

CHROMITING®



Autoperforante ed autofilettante

CHROMITING®



Per legno

CHROMITING®



Per legno

INOX PASSIVATA LUCIDA E LUBRIFICATA



Autofilettante ed automaschiante, con testa in plastica

CHROMITING®



Autoperforante ed autofilettante, con testa in plastica

CHROMITING®







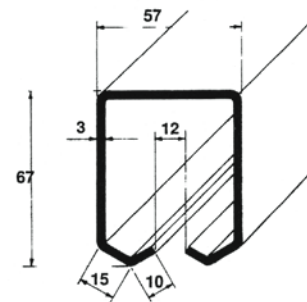

Per legno, con testa in plastica

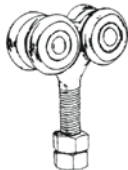
CHROMITING®







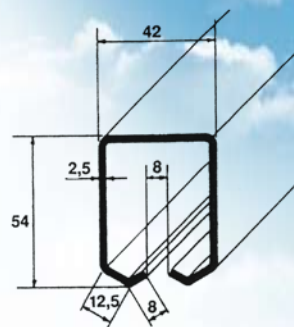

Monorotaia tipo A

ART.		SIGLA	CARATTERISTICHE	PORTATE KG.
1		2RA	Carrello scorrevole Corpo fisso in acciaio forgiato e zincato Ruote tornite e zincate Ø55	Per 2 carrelli kg. 420
2		4RA	Carrello scorrevole Corpo fisso in acciaio forgiato e zincato Ruote tornite e zincate Ø55	Per 2 carrelli kg. 780 Supporto monorotaia ogni 70 cm.
3		2RAS	Carrello scorrevole Corpo snodato in acciaio forgiato e zincato Ruote tornite e zincate Ø55	Per 2 carrelli kg. 420 Supporto monorotaia ogni 70 cm.
4		4RAS	Carrello scorrevole Corpo snodato in acciaio forgiato e zincato Ruote tornite e zincate Ø55	Per 2 carrelli kg. 780 Supporto monorotaia ogni 70 cm.
5		2RAL	Carrello scorrevole con cerniera a 1 ALA per porte a libro Corpo in acciaio forgiato e zincato Ruote tornite e zincate Ø55	Per 2 carrelli kg. 420 Supporto monorotaia ogni 70 cm.
6		4RAL	Carrello scorrevole con cerniera a 3 ALI per porte a libro Corpo in acciaio forgiato e zincato Ruote tornite e zincate Ø55	Per 2 carrelli kg. 780 Supporto monorotaia ogni 70 cm.
7		4RALL	Carrello scorrevole con cerniera a 1 ALA per porte a libro Corpo in acciaio forgiato e zincato Ruote tornite e zincate Ø55	Per 2 carrelli kg. 780 Supporto monorotaia ogni 70 cm.





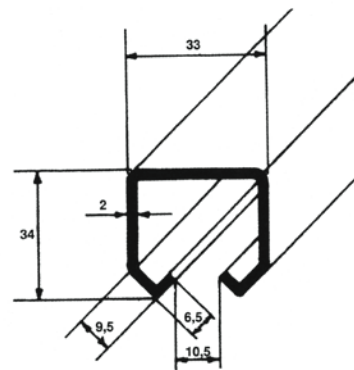

Monorotaia tipo B



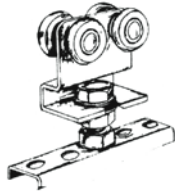



ART.		SIGLA	CARATTERISTICHE	PORTATE KG.
8		2RB	Carrello scorrevole Corpo fisso in acciaio forgiato e zincato Ruote tornite e zincate Ø45	Per 2 carrelli kg. 222 Supporto monorotaia ogni 70 cm.
9		4RB	Carrello scorrevole Corpo fisso in acciaio forgiato e zincato Ruote tornite e zincate Ø45	Per 2 carrelli kg. 670 Supporto monorotaia ogni 70 cm.
10		2RBS	Carrello scorrevole Corpo snodato in acciaio forgiato e zincato Ruote tornite e zincate Ø45	Per 2 carrelli kg. 220 Supporto monorotaia ogni 70 cm.
11		4RBS	Carrello scorrevole Corpo snodato in acciaio forgiato e zincato Ruote tornite e zincate Ø45	Per 2 carrelli kg. 670 Supporto monorotaia ogni 70 cm.
12		2RBL	Carrello scorrevole con cerniera a 1 ALA per porte a libro Corpo in acciaio forgiato e zincato Ruote tornite e zincate Ø45	Per 2 carrelli kg. 220 Supporto monorotaia ogni 70 cm.
13		4RBL	Carrello scorrevole con cerniera a 3 ALI per porte a libro Corpo in acciaio forgiato e zincato Ruote tornite e zincate Ø45	Per 2 carrelli kg. 670 Supporto monorotaia ogni 70 cm.
14		4RBLL	Carrello scorrevole con cerniera a 1 ALA per porte a libro Corpo in acciaio forgiato e zincato Ruote tornite e zincate Ø45	Per 2 carrelli kg. 670 Supporto monorotaia ogni 70 cm.







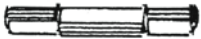





Monorotaia tipo C

ART.		SIGLA	CARATTERISTICHE	PORTATE KG.
15		2RC	Carrello scorrevole Corpo fisso in lamiera stampata e zincata Ruote tornite e zincate Ø24	Per 2 carrelli kg. 50
16		4RC	Carrello scorrevole Corpo fisso in lamiera stampata e zincata Ruote tornite e zincate Ø24	Per 2 carrelli kg. 75
17		4RCF	Carrello scorrevole Corpo fisso in acciaio forgiato e zincato Ruote tornite e zincate Ø24	Per 2 carrelli kg. 75
18		2RCF	Carrello scorrevole Corpo fisso in acciaio forgiato e zincato Ruote tornite e zincate Ø24	Per 2 carrelli kg. 50
19		TC4R/I	Carrello 4 ruote Mezza luna Cuscinetti Ø24	

Accessori per carrelli per porte a libro

ART.		SIGLA	CARATTERISTICHE
20		P1ALA A - B	Perno inferiore - Oliva ottone - Ø 25-30 - 1 ALA
21		PTA	Perno inferiore - Tipo grande oliva ottone - Ø 25-30 - 1 ALI
22		PTB	Perno inferiore - Tipo medio oliva ottone - Ø 25-30 - 1 ALI
23		D	Deviatore per articolazione ante
24		PF	Oliva ottone Ø 25 con perno filettato M 12
25		C17	Cerniera a 3 ALI (perno a sfilare) da mm. 170
26		C20	Cerniera a 3 ALI (perno a sfilare) da mm. 200

Accessori per carrelli per porte a libro

ART.		SIGLA	CARATTERISTICHE
27		TACS	Staffa snodata tipo grande con sfere
28		TBCS	Staffa snodata tipo medio con sfere
29			Piastra zincata 4 rulli regolabili Ø 35 Regolazione interna da mm. 28 a mm. 60
30			Oliva cilindrica in nylon Ø 35
31			Oliva bombata in nylon Ø 35 - 42
32			Oliva cilindrica in nylon Ø 25 - 30 - 40 - 47
33			"Spazzola" per portoni
34			Oliva ottone Ø 25 - 30 con piastra
35			Battente d'arresto per cancelli scorrevoli
36			Battente d'arresto centrale per cancelli a 2 ante



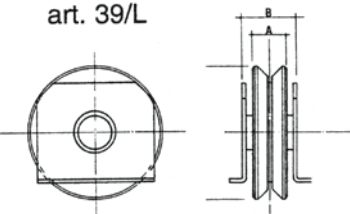
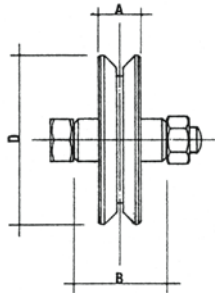
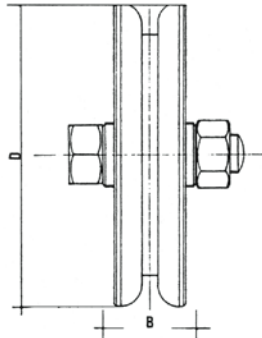
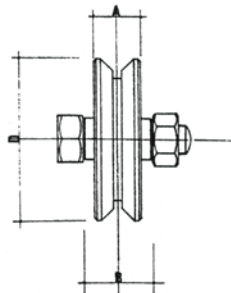



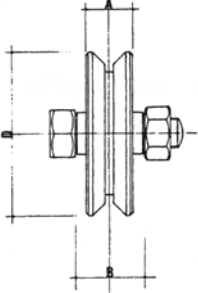
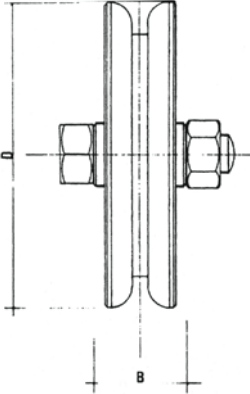
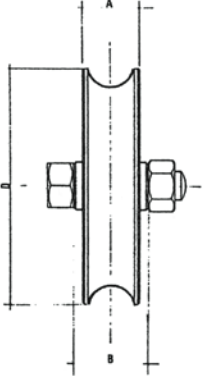

Ruote in acciaio tornito e zincato

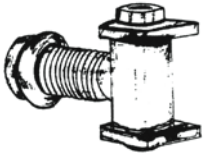

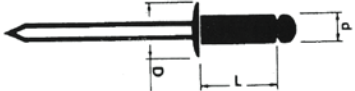
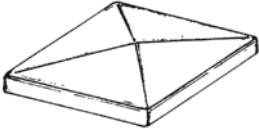

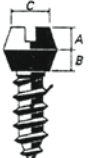

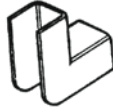

ART.		CARATTERISTICHE																																								
39 L	 <p>art. 39/L</p>	<p style="background-color: #fff2cc; margin-bottom: 5px;">RUOTA CON SUPPORTO A SALDARE</p> <table border="1" style="width: 100%; border-collapse: collapse;"> <thead> <tr style="background-color: #d9ead3;"> <th>D</th> <th>A</th> <th>B</th> <th>Portata kg.</th> </tr> </thead> <tbody> <tr><td>80</td><td>20</td><td>34</td><td>210</td></tr> <tr><td>90</td><td>20</td><td>34</td><td>210</td></tr> <tr><td>100</td><td>20</td><td>34</td><td>210</td></tr> <tr><td>120</td><td>20</td><td>34</td><td>210</td></tr> </tbody> </table>	D	A	B	Portata kg.	80	20	34	210	90	20	34	210	100	20	34	210	120	20	34	210																				
D	A	B	Portata kg.																																							
80	20	34	210																																							
90	20	34	210																																							
100	20	34	210																																							
120	20	34	210																																							
39																																										
40		<p style="background-color: #fff2cc; margin-bottom: 5px;">RUOTA RIDOTTA CON 1 CUSCINETTO</p> <table border="1" style="width: 100%; border-collapse: collapse;"> <thead> <tr style="background-color: #d9ead3;"> <th>D</th> <th>A</th> <th>B</th> <th>C</th> <th>Portata kg.</th> </tr> </thead> <tbody> <tr><td>60</td><td>20</td><td>43</td><td>8</td><td>180</td></tr> <tr><td>80</td><td>20</td><td>43</td><td>8</td><td>280</td></tr> <tr><td>90</td><td>20</td><td>43</td><td>8</td><td>280</td></tr> <tr><td>100</td><td>20</td><td>43</td><td>8</td><td>280</td></tr> <tr><td>120</td><td>20</td><td>43</td><td>8</td><td>280</td></tr> <tr><td>150</td><td>20</td><td>43</td><td>10</td><td>350</td></tr> <tr><td>160</td><td>20</td><td>4</td><td>10</td><td>350</td></tr> </tbody> </table>	D	A	B	C	Portata kg.	60	20	43	8	180	80	20	43	8	280	90	20	43	8	280	100	20	43	8	280	120	20	43	8	280	150	20	43	10	350	160	20	4	10	350
D	A	B	C	Portata kg.																																						
60	20	43	8	180																																						
80	20	43	8	280																																						
90	20	43	8	280																																						
100	20	43	8	280																																						
120	20	43	8	280																																						
150	20	43	10	350																																						
160	20	4	10	350																																						
41		<p style="background-color: #fff2cc; margin-bottom: 5px;">RUOTA RIDOTTA CON 2 CUSCINETTI GOLA SEMICIRCOLARE</p> <table border="1" style="width: 100%; border-collapse: collapse;"> <thead> <tr style="background-color: #d9ead3;"> <th>D</th> <th>A</th> <th>B</th> <th>C</th> <th>Portata kg.</th> </tr> </thead> <tbody> <tr><td>60</td><td>25</td><td>33</td><td>8</td><td>500</td></tr> <tr><td>80</td><td>25</td><td>33</td><td>8</td><td>500</td></tr> <tr><td>100</td><td>25</td><td>33</td><td>8</td><td>500</td></tr> <tr><td>120</td><td>25</td><td>33</td><td>8</td><td>500</td></tr> <tr><td>150</td><td>25</td><td>33</td><td>10</td><td>500</td></tr> </tbody> </table>	D	A	B	C	Portata kg.	60	25	33	8	500	80	25	33	8	500	100	25	33	8	500	120	25	33	8	500	150	25	33	10	500										
D	A	B	C	Portata kg.																																						
60	25	33	8	500																																						
80	25	33	8	500																																						
100	25	33	8	500																																						
120	25	33	8	500																																						
150	25	33	10	500																																						
42		<p style="background-color: #fff2cc; margin-bottom: 5px;">RUOTA CON 1 CUSCINETTO</p> <table border="1" style="width: 100%; border-collapse: collapse;"> <thead> <tr style="background-color: #d9ead3;"> <th>D</th> <th>A</th> <th>B</th> <th>C</th> <th>Portata kg.</th> </tr> </thead> <tbody> <tr><td>80</td><td>30</td><td>43</td><td>18</td><td>300</td></tr> <tr><td>100</td><td>30</td><td>43</td><td>18</td><td>300</td></tr> <tr><td>120</td><td>30</td><td>43</td><td>18</td><td>300</td></tr> <tr><td>150</td><td>30</td><td>43</td><td>18</td><td>350</td></tr> <tr><td>200</td><td>30</td><td>43</td><td>18</td><td>350</td></tr> </tbody> </table>	D	A	B	C	Portata kg.	80	30	43	18	300	100	30	43	18	300	120	30	43	18	300	150	30	43	18	350	200	30	43	18	350										
D	A	B	C	Portata kg.																																						
80	30	43	18	300																																						
100	30	43	18	300																																						
120	30	43	18	300																																						
150	30	43	18	350																																						
200	30	43	18	350																																						

Ruote in acciaio tornito e zincato

ART.		CARATTERISTICHE																								
43		<p>RUOTA CON DUE CUSCINETTI - GOLA V</p> <table border="1"> <thead> <tr> <th>D</th> <th>A</th> <th>B</th> <th>Portata kg.</th> </tr> </thead> <tbody> <tr> <td>100</td> <td>30</td> <td>43</td> <td>600</td> </tr> <tr> <td>120</td> <td>30</td> <td>43</td> <td>600</td> </tr> <tr> <td>150</td> <td>30</td> <td>43</td> <td>800</td> </tr> <tr> <td>200</td> <td>30</td> <td>43</td> <td>800</td> </tr> <tr> <td>250</td> <td>40</td> <td>53</td> <td>1000</td> </tr> </tbody> </table>	D	A	B	Portata kg.	100	30	43	600	120	30	43	600	150	30	43	800	200	30	43	800	250	40	53	1000
D	A	B	Portata kg.																							
100	30	43	600																							
120	30	43	600																							
150	30	43	800																							
200	30	43	800																							
250	40	53	1000																							
44		<p>RUOTA CON DUE CUSCINETTI - GOLA SEMICIRCOLARE</p> <table border="1"> <thead> <tr> <th>D</th> <th>A</th> <th>B</th> <th>Portata kg.</th> </tr> </thead> <tbody> <tr> <td>150</td> <td>33</td> <td>43</td> <td>800</td> </tr> <tr> <td>200</td> <td>33</td> <td>43</td> <td>800</td> </tr> </tbody> </table>	D	A	B	Portata kg.	150	33	43	800	200	33	43	800												
D	A	B	Portata kg.																							
150	33	43	800																							
200	33	43	800																							
45		<p>RUOTA CON DUE CUSCINETTI - COLA TONDA</p> <table border="1"> <thead> <tr> <th>D</th> <th>A</th> <th>B</th> <th>Portata kg.</th> </tr> </thead> <tbody> <tr> <td>80</td> <td>25</td> <td>33</td> <td>500</td> </tr> <tr> <td>100</td> <td>25</td> <td>33</td> <td>500</td> </tr> <tr> <td>120</td> <td>25</td> <td>33</td> <td>500</td> </tr> <tr> <td>150</td> <td>25</td> <td>33</td> <td>500</td> </tr> </tbody> </table>	D	A	B	Portata kg.	80	25	33	500	100	25	33	500	120	25	33	500	150	25	33	500				
D	A	B	Portata kg.																							
80	25	33	500																							
100	25	33	500																							
120	25	33	500																							
150	25	33	500																							

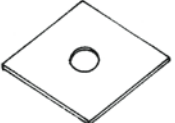
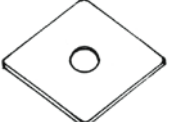
Ruote di dimensioni diverse possono essere fornite a richiesta

ART.		CARATTERISTICHE
46		<p>Cardine a saldare (interamento tornito) normale 20 MA maggiorato 24 MA</p>
47		<p>Perno mm. 30 x 30 per cardine 20 MA mm. 35 x 35 per cardine 24 MA</p>
48		<p>Piastra mm. 60 x 60 x 15 per cardine 20 MA mm. 70 x 70 x 15 per cardine 24 MA</p>
49		<p>Rivetti</p>
50		<p>Caschi Copricolonna in ferro 30 x 30 / 40 x 40 / 50 x 50 / 60 x 60 80 x 80 / 100 x 100 / 120 x 120 / 150 x 150</p>
51		<p>Tappi e Caschi copricolonna in nylon Ø33 - 42 - 48 - 60 50 x 20 / 80 x 20 30 x 30 / 40 x 40 / 50 x 50 / 60 x 60 / 80 x 80 / 100 x 100 / 120 x 120 / 150 x 150</p>
52		<p>Viti autoflettanti per fermavetro da mm. 10 - 12 (zincate)</p>
53		<p>Vite a scatto in nylon per fermavetri da mm. 10 - 12</p>
54		<p>Copriangolo zincato per fermavento da mm. 10 - 12</p>
55		<p>Cartucce silicone neutro - grigio - testa di moro - rosso - nero</p>

ART.		CARATTERISTICHE																								
56		Schiuma poliuretano in bombole spray																								
57		Cappucci di fissaggio per lamiere e pannelli con guarnizione adesivi																								
58		Rondelle in alluminio e gomma per fissaggio lastre policarbonato																								
59		Tasselli in nylon L. 40 - 60 mm.																								
61		<p>Barretta zincata completa di dado</p> <table border="1" data-bbox="721 967 1337 1057"> <thead> <tr> <th>Ø</th> <th colspan="7">lunghezza</th> </tr> </thead> <tbody> <tr> <td>5</td> <td>100</td> <td>120</td> <td>150</td> <td>200</td> <td>250</td> <td>300</td> <td></td> </tr> <tr> <td>6</td> <td>150</td> <td>200</td> <td>250</td> <td>300</td> <td>350</td> <td>400</td> <td></td> </tr> </tbody> </table>	Ø	lunghezza							5	100	120	150	200	250	300		6	150	200	250	300	350	400	
Ø	lunghezza																									
5	100	120	150	200	250	300																				
6	150	200	250	300	350	400																				
62		<p>Rondella romboidale in plastica dimensioni mm. 27 x 27 30 x 30 40 x 40</p>																								
63		<p>Rondella romboidale in Ruberoid dimensioni mm. 27 x 27 30 x 30 40 x 40</p>																								
64		<p>Rondella romboidale in ferro zincata dimensioni mm. 27 x 27 30 x 30 40 x 40</p>																								
65		<p>Catramino rettangolare Runeroid dimensioni mm. 45 x 45 45 x 45</p>																								
66		<p>Rondella nylon per viti a testa esagonale foro Ø 6 mm.</p>																								
67		<p>Rondella conica inox con guarnizione in EPDM</p>																								